

# WE BUILD PRODUCTS THAT EXTRACT OIL AND GAS

Throughout the world's oil and gas producing regions, operators and service companies alike rely on Hunting's vast array of Well Construction, Well Completion and Well Intervention products and services to satisfy critical stages of the exploration and production process.

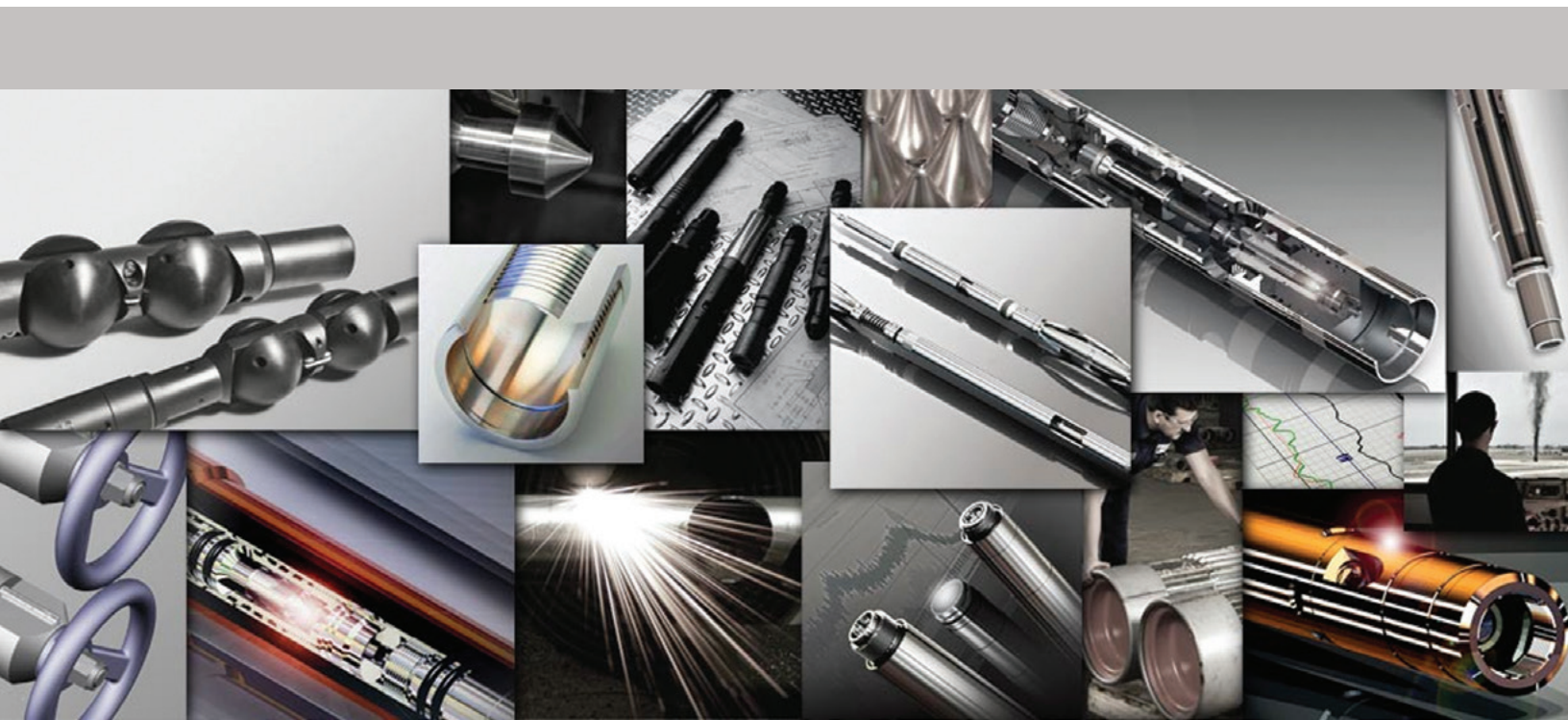

# One-Stop Services for a Global Industry

Hunting Manufacturing and Machining Services provides a wide range of standard and customized solutions that help you safely and productively minimize downhole risk and solve ever more complex problems.

Guided by our belief in *Total Customer Satisfaction*, Hunting works to ensure that the performance you expect is built into every product and service provided.

We are the single resource you can confidently go to for your product or service request.

## Licensed Threads

Hunting's worldwide network of proprietary and premium-licensed threading facilities can machine a full range of API and premium-licensed threads onto manufactured and free-issue components.

The facilities can thread full length and accessory components from .750-in. to 20-in. diameters, or provide premium threads on OEM equipment.

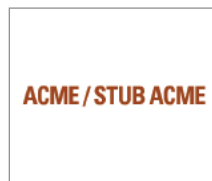
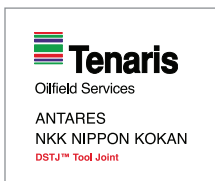

## WHY HUNTING IS RIGHT FOR YOU

- A firmly entrenched “can do” culture and strong “sense of urgency”
- Highly efficient, precision machining
- 5 Axis CNC machining technology
- Industry leading quality management system
- 24:7 responsiveness
- Global network of Hunting owned and licensed machining facilities, and supply infrastructure
- Full spectrum of completion accessories, API and premium connection threading, well intervention tools – slickline, wireline or coiled tubing – as well as print part manufacturing
- Reputation for “on-time delivery” and quality products
- Extensive material support network

# Fully Compliant Products, Standard-Setting Services

Hunting has provided excellence in energy services for more than 100 years. Keys to our success include our versatility, in-depth manufacturing capabilities, and responsiveness to our customers’ product needs.

With a manufacturing focus on completion accessories, premium threading, OEM well intervention tools and print part manufacturing, Hunting offers an unsurpassed product and service range to operator and OEM alike.

<p><b>Accessory Products</b></p> <ul style="list-style-type: none"> <li>■ Accessory print work machining</li> <li>■ Blast joints</li> <li>■ Bull plugs/bull caps</li> <li>■ Combo couplings</li> <li>■ Crossovers: Tubing/casing</li> <li>■ Couplings</li> <li>■ Double pin subs</li> <li>■ Drifts</li> <li>■ Flow couplings</li> <li>■ Flow tubes</li> <li>■ Half and full mule shoes</li> <li>■ Halliburton landing nipples</li> <li>■ Handling plugs: Single joint</li> <li>■ Landing joints</li> <li>■ Lift plugs: Multiple joint</li> <li>■ Polish bore receptacles (PBR)</li> <li>■ Perforated pup joints</li> <li>■ Pressure test fixtures</li> <li>■ Pup joints</li> <li>■ Re-entry guides</li> <li>■ Seal bore extensions</li> <li>■ Seal rings</li> <li>■ Stabbing guides</li> </ul>	<p><b>Services</b></p> <ul style="list-style-type: none"> <li>■ Assembly makeup, testing and fully enclosed storage for Range II, Range III up to 100 ft</li> <li>■ Blasting</li> <li>■ Completion schematics</li> <li>■ Coordination services</li> <li>■ Custom threading</li> <li>■ Drifting</li> <li>■ Electroplating: Copper, tin or zinc</li> <li>■ Proprietary and general manufacturing</li> <li>■ Internal coating</li> <li>■ Inventory control</li> <li>■ Mag particle inspection</li> <li>■ Non-destructive testing</li> <li>■ Part identification</li> <li>■ Peening</li> <li>■ Phosphating: Zinc/manganese</li> <li>■ Pressure testing</li> <li>■ Research and development</li> <li>■ Swaging mandreling/stress relief</li> <li>■ Test samples</li> <li>■ Thread repairs</li> </ul>	<p><b>Drill Stem Accessories</b></p> <ul style="list-style-type: none"> <li>■ API Spec 7</li> <li>■ Pup joints</li> <li>■ Circulating subs</li> <li>■ Crossovers/adapters</li> <li>■ Bit subs</li> <li>■ Lift subs</li> <li>■ Stabbing guides</li> <li>■ NOV Grant Prideco proprietary rotary shoulder threads</li> <li>■ TenarisHydril proprietary rotary shoulder threads</li> <li>■ Cold rolling of threads</li> <li>■ Pump in subs</li> <li>■ Cementing adapters</li> </ul>
--	---	---

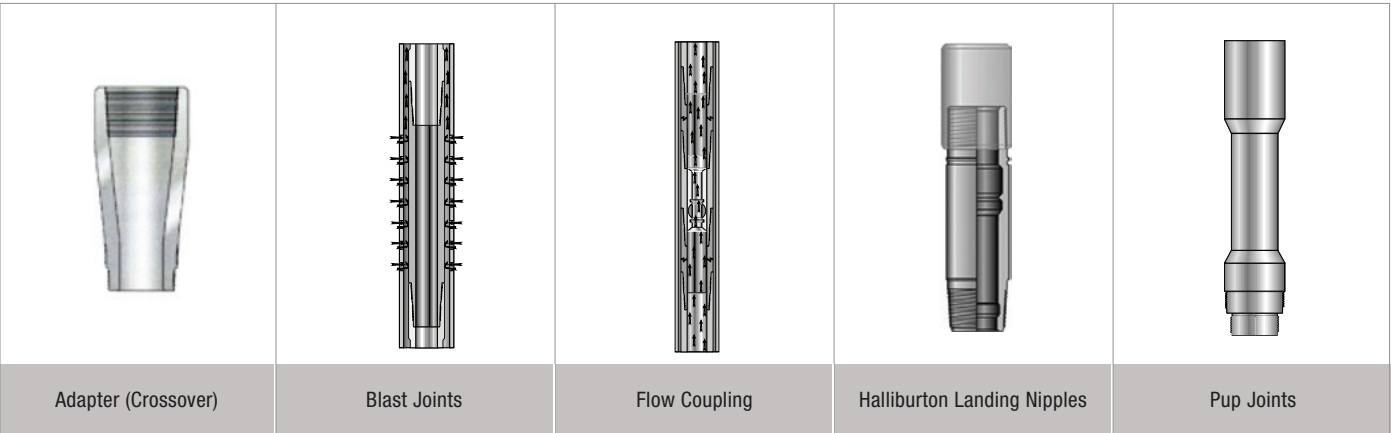

# Well Intervention Equipment

Hunting's manufacturing portfolio also includes equipment for downhole intervention in producing wells for logging or other well services. Our integrated solutions include pressure control equipment, a comprehensive range of slickline and e-line tools, and mechanical plant. Many of Hunting's products are manufactured from proprietary designs under license from major oilfield service companies.



## Pressure Control Equipment

- Wireline valves
- In-situ pressure test subs
- Lubricators
- Grease injection control heads
- Stuffing boxes

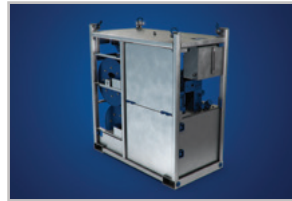

## Mechanical Plant

- Control panels
- Pressure testing equipment
- Shipping skids
- Containerized workshops



## Slickline Tools

- Rope sockets
- Stems
- Jars
- Running and pulling tools
- VariBall™ roller systems
- Halliburton Otis® certified
- Schlumberger Camco\*/Merla\*/Flopetrol\* certified

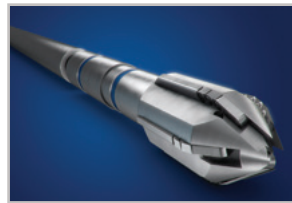

## Thru-tubing Technology

- Coiled tubing connectors
- Motorhead assemblies
- Check valves
- Disconnects
- Circulating subs
- Joints and stems
- Crossovers
- Centralizers
- Nozzles
- Motors
- Fishing tools
- Pipe cutters
- Halliburton-certified CT tools

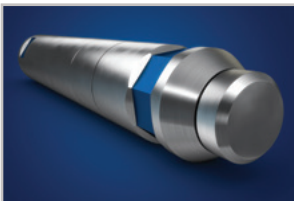

## E-line Tools

- Electric line rope sockets
- Swivels
- Crossover joints
- VariBall™ roller systems
- Halliburton Otis® certified
- Schlumberger Camco\*/Merla\*/Flopetrol\* certified





Hunting's Manufactured Products Are Built to Meet Your Costs and Operational Specs



## HEALTH, SAFETY AND ENVIRONMENTAL POLICY AND CERTIFICATIONS

**Hunting PLC is an international energy services provider to the world's leading oil and gas, and oilfield service companies. Its high standard of excellence is in part due to its unwavering adherence to its health, safety and environmental (HSE) policy and its full compliance with industry standards.**

### **Accessories and Print Work**

1018 Rankin Road  
Houston, Texas 77073-4606 USA  
Ph: 281-821-5577  
Fax: 281-821-6633  
**Email: [rankin.sales@hunting-intl.com](mailto:rankin.sales@hunting-intl.com)**

205 East Woodlawn Ranch Road  
Houma, Louisiana 70363-7146 USA  
Ph 1: 985-851-4170  
Ph 2: 800-776-0089  
Fax: 985-872-0373  
**Email: [houma.sales@hunting-intl.com](mailto:houma.sales@hunting-intl.com)**

118 Thruway Park Road  
Broussard, Louisiana 70518 USA  
Ph: 337-839-8344  
Fax: 716-945-2479  
**Email: [lafayette.quotes@hunting-intl.com](mailto:lafayette.quotes@hunting-intl.com)**

### **Pressure Control**

1018 Rankin Road  
Houston, Texas 77073-4606 USA  
Ph: 281-821-5577  
Fax: 281-821-6633  
**Email: [well.intervention.usa@hunting-intl.com](mailto:well.intervention.usa@hunting-intl.com)**

### **Well Intervention, Wireline, Coiled Tubing**

1717 Hwy 311  
Schriever, Louisiana 70395 USA  
Ph: 985-493-4800  
Fax: 985-493-4842  
**Email: [slickline.tools@hunting-intl.com](mailto:slickline.tools@hunting-intl.com)**

### **OEM and Print Work**

4400 N. Sam Houston Pkwy West  
Suite 320  
Houston, Texas 77086 USA  
Ph: 281-569-3700  
Fax: 281-781-0002  
**Email: [shp.sales.hunting-intl.com](mailto:shp.sales.hunting-intl.com)**

5223 West Orem Drive  
P.O. Box 35997  
Houston, Texas 77235 USA  
Ph: 713-433-3643  
Fax: 713-433-3520  
**Email: [doffing.sales@hunting-intl.com](mailto:doffing.sales@hunting-intl.com)**

### **South Texas Product Warehouse**

4473 Baldwin, Suite B  
Corpus Christi, Texas 78408 USA  
Ph: 361-887-2153  
Fax: 361-887-2154  
**Email: [corpus.sales@hunting-intl.com](mailto:corpus.sales@hunting-intl.com)**

"It is Hunting's HSE policy that all company business, management, and operational practices safeguard the health and safety of the company's employees, customers and vendors, and that all company business units consciously operate in a manner that includes environmental matters as an integral part of its business plan. It is the goal of Hunting PLC to be viewed by the communities that we work and live in as good corporate citizens through managing Health, Safety and Environmental issues as a top priority. Simply put: Hunting's goals are no accidents, no harm to people, and no damage to the environment."

### **Industry Certifications**

- **API Spec 5CT**
- **API Spec 7**
- **API Spec Q1**
- **ISO 9001:2008**
- **ISO/TS29001**
- **ISO 14001:2004**
- **QA SAS:18001**

### **For international inquiries:**

**[international.accessories@hunting-intl.com](mailto:international.accessories@hunting-intl.com)**



'Excellence in **Energy Services** for over 100 years'

[www.huntingplc.com](http://www.huntingplc.com)